

**3 END CAP**  
SCALE: 6"=1'-0"

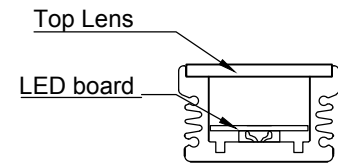
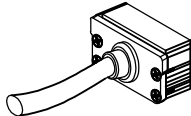
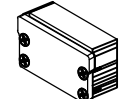
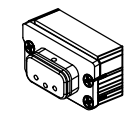
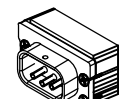
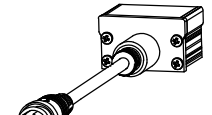
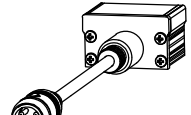

**4 SECTION**  
SCALE: 6"=1'-0"

**END CAP CONDITIONS**

 POWER FEED (PF)	 CLOSED END (CE)
 FEMALE (F)	 MALE (M)
 FEMALE TWIST LOCK	 MALE TWIST LOCK

**MOUNTING OPTIONS**

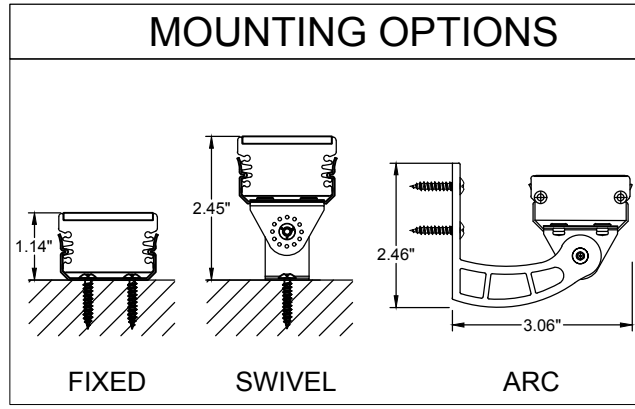

**TECHNICAL DATA**

Parameter	Data
Power	8 watts per linear ft
Input Voltage	24VAC
Input Current per Linear Ft	410mA
Control	Standard Magnetic Low Voltage Dimming
Power Cable Length	UL Standard 6ft
LED Spacing	0.63" on center
Fixture Length	12"-72", in 6" increment
Fixture Width	1.68"
Total Height (not including clip)	1.04"
Mounting	Fixed, Swivel, 3" Arc Bracket & 6" Arc Bracket
Available Optics	120°
Finish Options	Clear or Black Anodized Aluminum
LED Color Options	27K, 3K, 35K, 4K, 5K
Color Rendering Index	90+ CRI
Ratings	Dry, IP65, IP68
Total linear ft per 20A breaker	150ft@120V or 330ft@277V
Total linear ft per 15A breaker:	112ft@120V or 240ft@277V
Total linear ft per power feed	6ft
Transformer	Primary 120V or 277V, Secondary 12V



LED Lighting Systems, Technologies, & Manufacturing

508 South Military Trail      www.BocaFlasher.com  
Deerfield Beach FL, 33442      (561) 989-5338

THIS DOCUMENT IS CONFIDENTIAL AND PROTECTED BY COPYRIGHTS OF BOCA FLASHER INC.

REV 04082019

**LUMELINE-RT**

FILE NAME:	TECHNICAL SHEET	PART #:	LUMELINE-RT
DRAWN BY:	STEPHANIE BURKE		02 / 23 / 15
DESIGN BY:	MATTHEW WOOD		04 / 04 / 13
APPROVED BY:	STEPHANIE BURKE		02 / 23 / 15
SCALE:	NTS	SHEET:	1 OF 1