

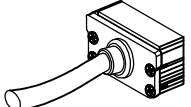

END CAP CONDITIONS	
 POWER FEED (PF)	 CLOSED END (CE)
 FEMALE (F)	 MALE (M)
 FEMALE TWIST LOCK	 MALE TWIST LOCK

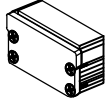
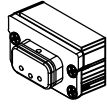
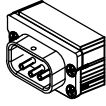
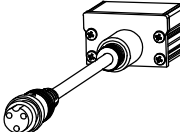
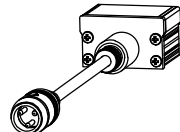
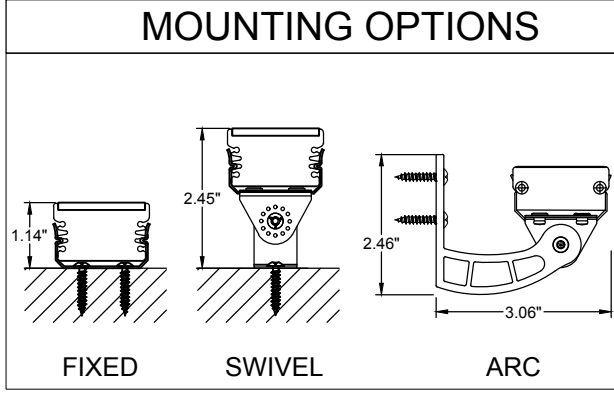

## TECHNICAL DATA

Parameter	Data
Power	10 watts per linear ft
Input Voltage	90-120V
Input Current per Linear Ft	85mA@120V
Control	Leading-edge/Trailing-edge line dimmer
Power Cable Length	UL Standard 6ft
LED Spacing	0.66" on center
Fixture Length	12"-96", in 6" increment
Fixture Width	1.68"
Total Height (not including clip)	1.04"
Mounting	Fixed, Swivel, 3" Arc Bracket & 6" Arc Bracket
Available Optics	120°
Finish Options	Clear or Black Anodized Aluminum
LED Color Options	27K, 3K, 35K, 4K, 5K
Color Rendering Index	90+ CRI
Ratings	Dry, IP65, IP68
Total linear ft per 20A breaker	128ft@120V or 280ft@277V
Total linear ft per 15A breaker:	96ft@120V or 210ft@277V
Total linear ft per power feed	56ft@120V or 120ft@277V
Transformer	N/A



LED Lighting Systems, Technologies, & Manufacturing

508 South Military Trail      www.BocaFlasher.com  
Deerfield Beach FL, 33442      (561) 989-5338

REV 04082019

# LUMELINE

FILE NAME:	TECHNICAL SHEET	PART #:	LUMELINE
DRAWN BY:	ANGELA TODD		02 / 20 / 15
DESIGN BY:	MATTHEW WOOD		
APPROVED BY:	STEPHANIE BURKE		
SCALE:	NTS	SHEET:	1 OF 1

THIS DOCUMENT IS CONFIDENTIAL AND PROTECTED BY COPYRIGHTS OF BOCA FLASHER INC.