

DATE:	TYPE:	PROJECT:	CUSTOMER:



Shallow Profile Linear LED Strip Fixture

Dimmable solid color line voltage fixture fabricated with a variety of options. The Boca HPNFC-HO is a shallow profile fixture well suited for many lighting situations where space is a concern. This line voltage version eliminates the need for secondary transformers, making installation contractor friendly. Boca's patented CleanDim® technology ensures even dimming from 0-100%. The HPNFC-HO can be fabricated with a range of optics and color temperature choices, affording a multitude of options. The housing is anodized aluminum with a durable finish making it weather and abrasion resistant. It is UL Listed for a dry, damp or wet location (model dependent).

Rendering is of HO6 version.

KEY FEATURES:

- Compact, variable light fixture for dry, damp or wet location use.
- Fixture comes in 6" increments (12" minimum)
- Many options in optics, color temperature and accessories.
- EMI Filter integral.
- Fixtures are compatible with both forward and reverse phase dimming or can use Boca's SDS module for 0-10V or DMX dimming.
- Uses standard line voltage dimmers.
- Clear anodized aluminum or black finish standard.
- Contact Boca Flasher for tips with custom installations.
- Total linear foot per power feed: HO6 = 80 ft., HO8 = 65 ft.

LENS OPTIONS:

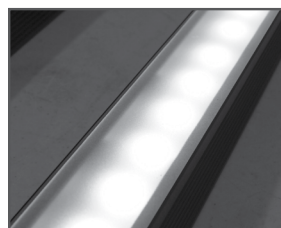

Diffused*

Key Features:

- Interior or exterior use.
- Lens is 1/8" (.09) thick, adds 1/16" to overall height of fixture.
- Call factory for more information.
- 87% transmission.

* Additional charges apply.

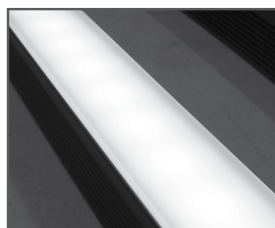

Satin Ice White*

Key Features:

- Interior use only.
- Best for direct view use.
- Lens is 1/4" (.25) thick, adds 1/8" to overall height of fixture.
- Call factory for more information.
- 42% transmission.

* Additional charges apply.

TECHNICAL SPECIFICATIONS:

WATTAGE: 8 or 10 watts per linear ft.	TOTAL HEIGHT: Not including clip 1.04"
INPUT VOLTAGE: 90-120 VAC or 230-277 VAC	MOUNTING: Fixed, swivel, 3" arc or 6" arc.
CONTROL: Leading edge/trailing edge line dimming 0-10V, DMX.*	COLOR OPTIONS: 2700K, 3000K, 3500K, 4000K, 5000K, amber, red, green, blue.
LED SPACING: 2" on center for HO6 1.5" on center for HO8	OPTICS AVAILABLE: 10°, 30°, 60°, 10° x 60°, 30° x 60°, 120°
LENGTH: 12"-96", 6" increments.	RATING: IP50, IP65, IP68
COLOR RENDERING INDEX (CRI): 90 + CRI	POWER CABLE: UL standard 6 ft.
	TOTAL WIDTH: 1.68"

*Use Boca SDS module for 0-10V or DMX Dimming.

PROJECT SPECIFICATIONS:

HPNFC				
	HO6 = 8 LED's per linear ft. (8 watts) HO8 = 10 LED's per linear ft. (10 watts)	COLOR OPTION: 2700K, 3000K, 3500K, 4000K, 5000K, amber, red, green, blue	OPTIC: 10°, 30°, 60°, 10° x 60°, 30° x 60°, 120°	VOLTAGE: 90-120VAC = 120V 230-277VAC = 277V
FINISH: Clear Anodized Aluminum = A Black = B	LOCATION: Interior = I Exterior (IP65) = E Wet (IP68) = W	MOUNTING: Fixed = F Swivel = S 3" Arc Swivel = 3Arc 6" Arc Swivel = 6Arc	LENS: Clear = C Diffused Lens = D Satin Ice White = SI* <small>*Interior Use Only</small>	OPTIONS: Hexcell Louver = HL* Square Baffle = SB Slanted Baffle = SSB Square Kicker Baffle = SKB <small>*Cannot be used with Satin Ice White or 120° optic</small>

DATE:	TYPE:	PROJECT:	CUSTOMER:

BODY CHOICES:

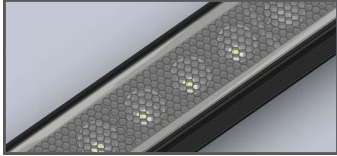

Hexcell Louver

Key Features:

- Economical solution to off axis glare issues.
- Louver is located flush to secondary optic, preventing unwanted striation.
- Louver cannot be utilized when no optic (120°) is specified.
- Louver is behind lens to ensure no damage is done during installation or after. This also ensures no dust build-up.
- Louver ships pre-fitted making on site fixture installation easy.

- No unsightly clips, screws, or brackets.
 - Can be used with other baffles.
 - Adds nothing to overall height.
 - To specify add **"HL"** in options box.
- *Additional charges may apply.

Diagram:

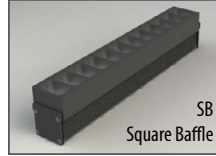
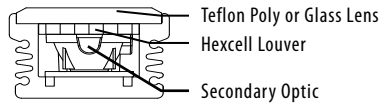

Baffle Square Design

Key Features:

- Design cuts off light at 90°
- Baffles are lightweight black PVC with non-reflective surfaces to avoid glare from interior sections.
- One piece baffle slides onto the extruded housing making installation easy.
- SB only adds .75" to overall height
- SSB adds .90" to overall height
- SKB adds 1.625" to overall height
- To specify add **"SB"** or **"SSB"** for slanted version or **"SKB"** for kicker version in options box.

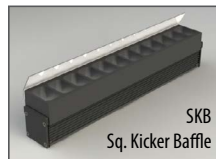

DIAGRAMS & DIMENSIONS:

PLAN VIEW

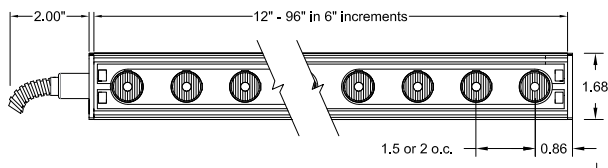

ELEVATION VIEW

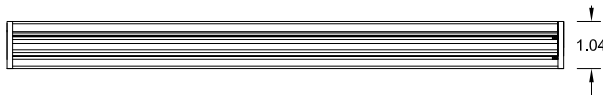

*Fixture is shown with interior power feed

MOUNTING INFORMATION:

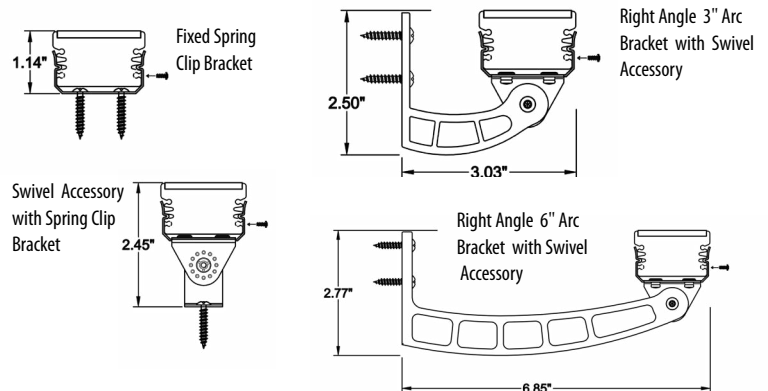

* For vertical installation please contact the factory for specific mounting instructions.