

END CAP CONDITIONS	
 POWER FEED (PF)	 CLOSED END (CE)
 FEMALE (F)	 MALE (M)
 FEMALE (F)	 MALE (M)

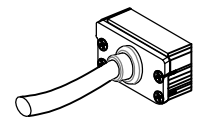
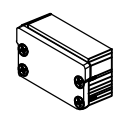
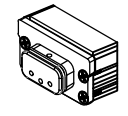
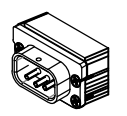
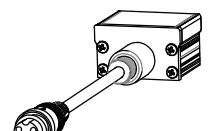
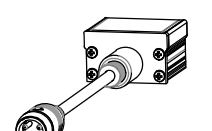
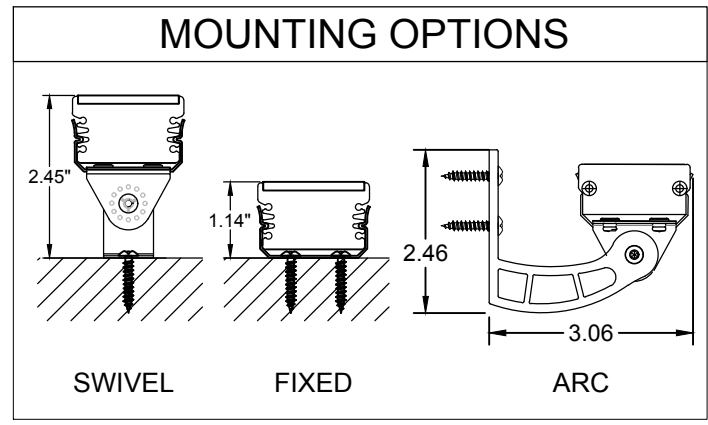

TECHNICAL DATA	
Parameter	Data
Wattage	8 watts per linear ft.
Input Voltage	12VAC
Input Current per Linear Ft	410mA
Control	Standard Magnetic Low Voltage Dimming
Power Cable Length	UL Standard 6ft
LED Spacing	1.5" on center
Fixture Length	12"-72", in 6" increment
Fixture Width	1.68"
Total Height (not including clip)	1.75"
Mounting	Fixed, Swivel, 3" or 6" Arc Bracket
Available Optics	10°, 30°, 60°, 10°x60°, 30°x60°, 120°
Finish Options	Clear or Black Anodized Aluminum
LED Color Options	27K,3K,35K,4K,5K,Amber,Red,Green,Blue
Color Rendering Index	90+ CRI
Ratings	Dry, IP65, IP68
Total linear ft per 20A breaker	150ft@120V or 330ft@277V
Total linear ft per 15A breaker:	112ft@120V or 240ft@277V
Total linear ft per power feed	6ft
Transformer	Primary 120V or 277V, Secondary 12V

**BOCA FLASHER**

LED Lighting Systems, Technologies & Manufacturing

508 SO. MILITARY TRL. DEERFIELD BEACH, FL 33442

www.bocafasher.com (561) 989-5338

THIS DOCUMENT IS CONFIDENTIAL AND PROTECTED BY COPYRIGHTS OF BOCA FLASHER INC.

### HPNFC - RT

FILE NAME:	TECHNICAL SHEET	PART #:	HPNFC-RT
DRAWN BY:	DEMMLER FILLINGER		04 / 26 / 13
DESIGN BY:	LUIS ROSADO		
APPROVED BY:	ANGELA TODD		04 / 26 / 13
SCALE:	NTS	SHEET:	1 OF 1